

Tende a bracci
Retractable Awnings

“Ecco l’unica cosa che mi piacerebbe veramente di tenere in pugno, il suono dell’ombra”

Alda Merini

“Here is the only thing I’d like to hold in my fist, the sound of shade”

Alda Merini

Indice

Tende a bracci . p4

Feng . p6

Shan . p14

Edge . p22

Kumo . p30

Yuki . p38

Ilioswing . p46

Yama . p52

Svet . p58

Klip . p64

Stein . p70

Index

Retractable awnings . p4

Feng . p6

Shan . p14

Edge . p22

Kumo . p30

Yuki . p38

Ilioswing . p46

Yama . p52

Svet . p58

Klip . p64

Stein . p70

TENDE A BRACCI . RETRACTABLE AWNINGS



SCAN ME

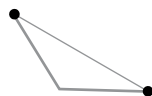

Linea design *Design line*

Feng
Shan
Edge
Kumo
Yuki
Ilioswing

Linea tradizionale *Traditional line*

Yama
Svet
Klip
Stein

Le tende da sole di design con bracci estensibili, motorizzate e illuminazione a LED.

Design e Made in Italy sono alla base di questa linea di tende da sole che unisce l'offerta di ShadeLAB nella sua essenza più elevata, senza rinunciare alla tradizione.

Una gamma che rappresenta l'eccellenza, nelle forme e nelle finiture, adatta alla casa, all'ufficio e al settore contract.

LINEA DI DESIGN

Le nostre tende da sole esclusive.

Una linea di prodotti funzionali, ricercati, semplicemente belli, in grado di soddisfare tutte le esigenze e adattarsi a qualsiasi contesto architettonico.

LINEA TRADIZIONALE

Le tende entry level. Tradizionali e accessibili.

Una linea che raccoglie le tende da sole che hanno fatto scuola, emblemi della tradizione italiana, intramontabili in termini di qualità e durabilità ed accessibili nel prezzo.

Design awnings with extendable, motorized arms and LED lighting.

Design and Made in Italy are at the heart of this awning line that combines the offer of ShadeLAB in its highest essence, without renouncing tradition.

A range that represents excellence, in shapes and finishes, suitable for the home, the office and the contract sector.

DESIGN LINE

Our exclusive design awnings.

A line of functional, sophisticated, simply beautiful products, able to meet all requirements and adapt to any architectural context.

TRADITIONAL LINE

The entry level awnings. Traditional and accessible.

A line that brings together the design awnings that have made school, emblems of Italian tradition, timeless in terms of quality and durability and affordable in price.



Prodotto in Italia
Made in Italy



Motorizzate
Motorized



Versatili
Versatile



Illuminazione a led
LED lighting

FENG



FENG, la coraggiosa.
Per chi non ha paura di osare.

*FENG, the brave one.
For those who are not afraid to dare.*

Con Feng esci dagli schemi classici per entrare nel nuovo concetto di tenda. Originale, diversa da tutte le altre, unica nel suo genere. Non teme confronti, non è paragonabile. Feng si distingue per il suo design rotondo. È la tenda come non l'hai mai vista.

Cosa mancava alla tua casa? Feng. Perché il tuo spazio merita il meglio. Con questa tenda rendi la tua abitazione esclusiva, confermandola definitivamente e finalmente come la più bella del vicinato. Probabilmente anche di tutta la città. Per te, che pretendi un'ombra spaziosa, dove poter assaporare i tuoi momenti di relax senza limiti, in totale libertà. Per te, che cerchi una soluzione che possa coprire ampie superfici, con tutto il comfort che meriti.

Feng ti dà di più. Di giorno ti regala l'ombra, di notte si illumina con le luci LED per accompagnare le tue serate estive e stupire i tuoi ospiti. Complimenti assicurati.

Forte e resistente, Feng soddisfa le tue richieste di affidabilità.

La qualità è la sua essenza e la sua garanzia, come comprovato dalla vincita, per questa tenda, del Good Design Award.

With Feng you break away from classic approaches to become acquainted with the new conception of awnings. Original, different from all the others, completely unique. It is not afraid of comparison, it is unparalleled. Feng stands out for its distinctive rounded design. It is the awning as you have never seen it before.

What was missing from your home? Feng. Because your space deserves the best. With this awning you will make your home exclusive, definitively confirming it as the finest in the neighbourhood. Perhaps even the entire city. For you, who expect a spacious shadow, where you can enjoy your moments of relaxation to the full, in total freedom. For you, who are looking for a solution that can cover large areas, with all the comfort you deserve.

Feng gives you more. During the day it gives you shade; at night it is illuminated with LED lights to accompany your summer evenings and astonish your guests. Compliments are guaranteed.

Strong and resistant, Feng meets your demands for reliability.

Quality is its essence and its guarantee, as proven by the winning of the Good Design Award for this awning.

PREMI . AWARDS



Good Design
Award
2018



A' Design
Award
2018

REGISTERED DESIGN 





SCAN ME



Lunghezza del braccio e inclinazione
Arm lenght and inclination

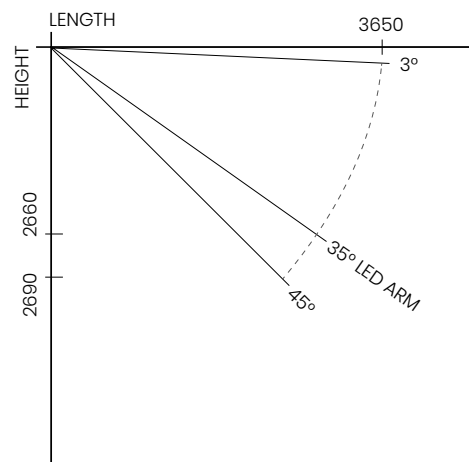

Le misure sono espresse in millimetri
Sizes are expressed in millimeters

Caratteristiche generali

- Tenda a cassonetto con bracci estensibili
- Installazione a parete e soffitto
- Inclinazione da 3° a 45° (35° braccio con LED)
- Tubo avvolgitore da 80 mm
- Braccio URBAN con DATSystem
- Optional nuovo Braccio URBAN LED
- Optional luce LED su cassonetto
- Dimensione massima modulo singolo 700x365 cm
- Solo motorizzata
- Sistema AcquaStop
- Regolazione micrometrica continua dell'inclinazione
- Viteria Inox certificata italiana
- Design brevettato in tutti gli stati della UE

Dimensioni della tenda chiusa
Awning sizes with folded arms

Installazione a parete
Wall installation

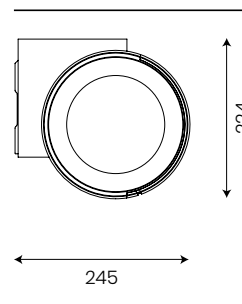

Inclinazione minima 3°
Inclinazione massima 45°
3° minimum inclination
45° maximum inclination

Installazione a soffitto
Ceiling installation

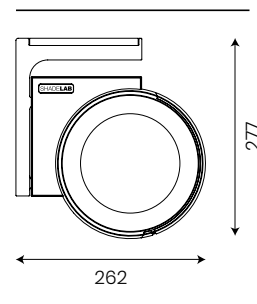

Inclinazione minima 3°
Inclinazione massima 45°
3° minimum inclination
45° maximum inclination

General features

- Retractable arm awning with cassette
- Wall and roof installation
- Inclination ranges between 3° and 45° (35° LED ARM)
- Roller tube 80 mm
- Arm URBAN with DATSystem
- Available with new URBAN LED arm
- Available with cassette LED system
- Maximum sizes of a single section: 700x365 cm
- Only motorized
- AcquaStop System
- Continuous micrometric regulation of inclination
- Certified Italian Stainless steel screws and pins
- Design patented in all EU Member States

Colori disponibili
Colours available

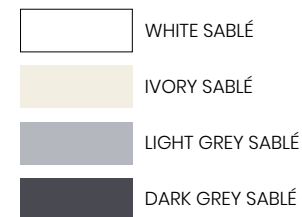

Premi
Awards







SCAN ME







SCAN ME



SHAN



SHAN, la maestosa.
Per chi non conosce confini.

*SHAN, the majestic one.
For those who know no boundaries.*

Shan è davvero la classica tenda del settore, quella tradizionale, che si integra perfettamente nell'architettura. Ma, cosa più importante, è la tenda più guardata, emulata, presa come esempio e riferimento. Sì, lei non ha paragoni, perché lei è il modello, la musa di tutte.

È la soluzione per coprire grandi spazi. Immagina la tua famiglia, i tuoi amici e le persone a te care riunite in una lunga tavolata di 5 metri. Ognuna di loro merita una dolce comodità. Shan ombreggia tutti i commensali, con semplicità e grazia.

Chi sa di essere non ha bisogno di apparire. Shan è consapevole del suo ruolo perché non viene mai scelta a caso. Troneggia nel tuo giardino con eleganza, come una vera regina, trasformando la tua casa in un castello.

Portatrice di qualità e forza, vincitrice del Red Dot Design award, tenace nel tempo.

Shan is truly the classic tent of the sector, with its traditional design, which blends perfectly into the architecture. But, more importantly, it is the most regarded and emulated tent, taken as an example and reference. Yes, she has no equals, because she is the model, the muse of all.

It is the solution for covering large spaces. Imagine your family, your friends and your loved ones gathered at a long table of 5 meters. Each of them deserves to be seated with the utmost comfort. Shan shades all diners with simplicity and grace.

Those who know they are do not need to appear. Shan is aware of her role because she is never chosen at random. She overlooks your garden with elegance, like a real queen, turning your home into a castle.

Bearer of quality and strength, winner of the Red Dot Design award, resistant over time.

PREMI . AWARDS



REGISTERED DESIGN 



Tested by:  TÜVRheinland®
Precisely Right.



SCAN ME



Lunghezza del braccio e inclinazione
Arm length and inclination

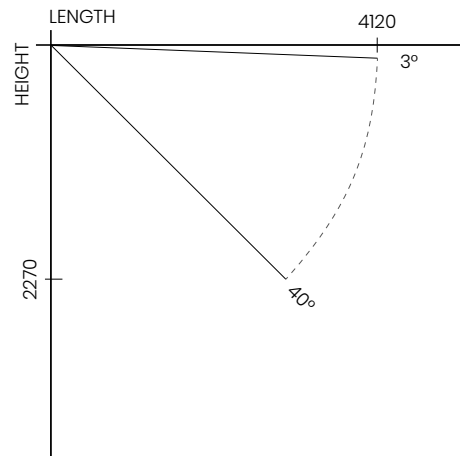

Le misure sono espresse in millimetri
Sizes are expressed in millimeters

Caratteristiche generali

- Tenda a cassonetto con bracci estensibili
- Installazione solo a parete
- Inclinazione da 3° a 40°
- Tubo avvolgitore da 80 mm
- Braccio URBAN KATANA con DATSystem
- Dimensione massima modulo singolo 700x415 cm
- Solo motorizzata
- Sistema AcquaStop
- Regolazione micrometrica continua dell'inclinazione
- Viteria Inox certificata italiana
- Certificazione TÜV Rheinland
- Design brevettato in tutti gli stati della UE
- Vincitrice del Red Dot Design Award 2010

Dimensioni della tenda chiusa
Awning sizes with folded arms

Installazione a parete o soffitto
Wall or ceiling installation

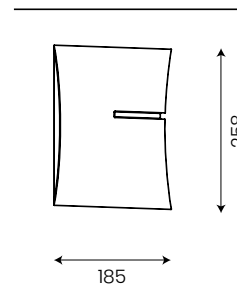

Inclinazione minima 3°
Inclinazione massima 40°
3° minimum inclination
40° maximum inclination

General features

- Retractable arm awning with cassette
- Only wall installation
- Inclination ranges between 0° and 40°
- Roller tube 80 mm
- Arm URBAN KATANA with DATSystem
- Maximum sizes of a single section: 700x415 cm
- Only motorized
- AcquaStop System
- Continuous micrometric regulation of inclination
- Certified Italian Stainless steel screws and pins
- Certified by TÜV Rheinland
- Design patented in all EU Member States
- 2010 Red Dot Design Award winner

Colori disponibili
Colours available

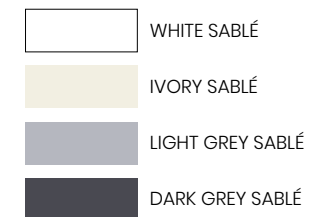





SCAN ME







SCAN ME



EDGE

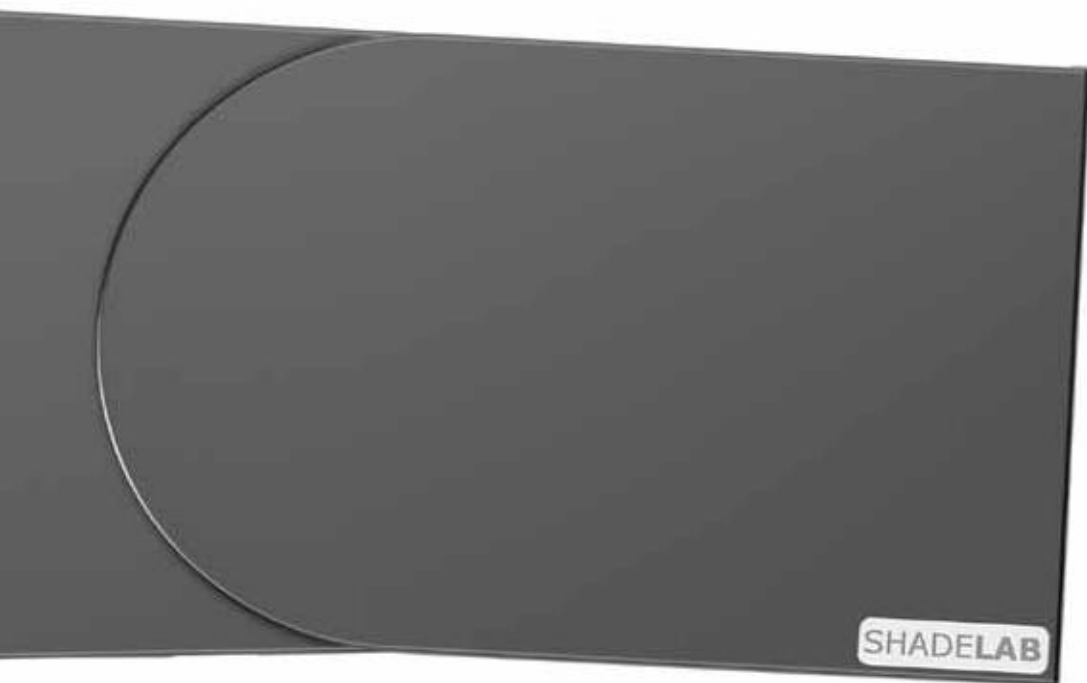

**SOON
AVAILABLE**

EDGE: La Pura.
Per chi ambisce alla perfezione.

*EDGE: the Pure.
For those who aim at perfection.*

Edge significa bordo, spigolo in inglese ed è una tenda innovativa che fa della forma e della pulizia del design il suo punto di forza.

La caratteristica principale è che tutte le componenti meccaniche sono rinchiusi in un'unica forma geometrica pulita, un prisma.

Lo sforzo di coniugare la forma con la funzione appare soprattutto nell'apertura e chiusura del profilo terminale che grazie a speciali accorgimenti non genera linee di rottura nella vista laterale e solo una linea nella vista frontale, anche i supporti laterali sono stati pensati per minimizzare gli spessori a vista, contribuendo a conferire al prodotto questo senso monolitico di forma pura.

Dal momento che tutte le tende da sole necessitano di un'inclinazione minima per poter garantire un minimo di pendenza del tessuto in caso di piogge inaspettate, nella configurazione a parete Edge nasce già con un'inclinazione minima di 3° senza compromettere gli allineamenti degli spigoli e la complanarità delle facce che la caratterizzano.

La tenda è equipaggiata con una lama di luce led nel cassonetto e anche nei bracci retrattili, garantendo un suggestivo effetto visivo quando la tenda è chiusa ed un'utile ed efficiente illuminazione quando è invece aperta.

Edge is a state-of-the-art awning that converts shape and clean design into strong points.

What makes it unique is the fact that all mechanical parts are enclosed in one clean geometric shape, a prism.

Shape meets functionality in the opening and closing system of the end profile, which has been specifically designed to be free from any break lines in the side view, with only one line in the front view; the side supports have also been designed to minimise the exposed spacers, giving the product this monolithic sense of pure form.

Since all awnings require a minimum pitch to guarantee a minimum slope of the fabric in the event of unexpected rain, the wall-mounted version of Edge is already designed with a minimum pitch of 3°, without compromising the alignment of edges and front sides.

The awning has a LED strip light installed in the cassette and also in the retractable arms, which guarantees an incredible visual effect when the awning is closed, while providing effective lighting when open.

REGISTERED DESIGN 



- Tenda a cassonetto con bracci estensibili
- Installazione a parete e soffitto
 - Inclinazione da 3° a 90°
 - Tubo avvolgitore da 80 mm
 - Braccio URBAN\KATANA con DATSystem
 - Dimensione massima modulo singolo 600x365 cm
 - Manuale o motorizzata
 - Led su bracci e cassonetto
 - Regolazione micrometrica continua dell'inclinazione
 - Viteria Inox certificata italiana
 - Certificazione TÜV Rheinland
 - Design brevettato in tutti gli stati della UE



Lunghezza del braccio e inclinazione
Arm lenght and inclination

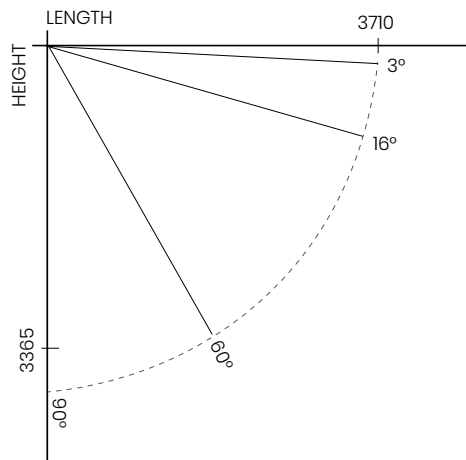

Le misure sono espresse in millimetri
Sizes are expressed in millimeters

Caratteristiche generali

- Tenda a cassonetto con bracci estensibili
- Installazione a parete e soffitto
- Inclinazione da 3° a 90°
- Tubo avvolgitore da 80 mm
- Braccio URBAN\KATANA con DATSystem
- Dimensione massima modulo singolo: 600x365 cm
- Manuale o motorizzata
- Led su bracci e cassonetto
- Regolazione micrometrica continua dell'inclinazione
- Viteria Inox certificata italiana
- Certificazione TÜV Rheinland
- Design brevettato in tutti gli stati della UE

Dimensioni della tenda chiusa
Awning sizes with folded arms

Installazione a parete
Wall installation

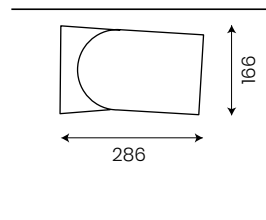

Inclinazione minima 3°
3° minimum inclination

Installazione a parete
Wall installation

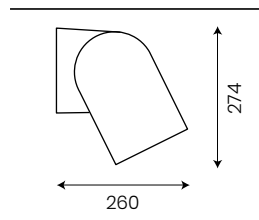

Inclinazione massima 63°
Maximum inclination 63°

Installazione a soffitto
Ceiling installation

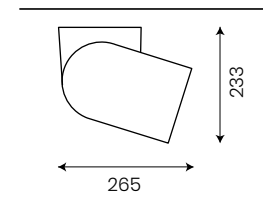

Inclinazione minima 16°
16° minimum inclination

Installazione a soffitto
Ceiling installation

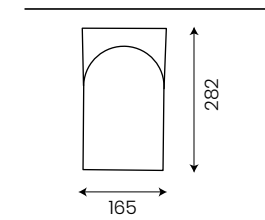

Inclinazione massima 90°
Maximum inclination 90°

General features

- Retractable arm awning with cassette
- Wall and ceiling installation
- Inclination ranges between 3° and 90°
- Roller tube 80 mm
- Arm URBAN\KATANA with DATSystem
- Maximum sizes of a single section: 600x365 cm
- Manually operated or motorized
- Led on arms and cassette
- Continuous micrometric regulation of inclination
- Certified Italian Stainless steel screws and pins
- Certified by TÜV Rheinland
- Design patented in all EU Member States

Colori disponibili
Colours available

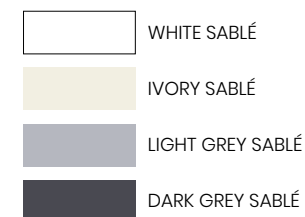









KUMO



KUMO, la più amata.
Per chi pone attenzione
ad ogni aspetto.

*KUMO, the most loved.
For those who pay attention
to every detail.*

Perché Kumo piace così tanto? Semplice, perché è capace di soddisfare tutte le esigenze. È la proposta di Shadelab che mette tutti d'accordo. La risposta quando chiedi un prodotto essenziale ma altamente funzionale e di qualità. Amata da tutti, da sempre.

L'equilibrio ottimale tra performance e prezzo. Il punto di incontro per ottenere il meglio con una giusta spesa.

Kumo si installa sia a parete che soffitto. Le dimensioni discrete la rendono la decisione più saggia per i condomini o per spazi limitati.

Why is Kumo so well-liked? Simple, because it is able to satisfy all needs. It is the proposal of Shadelab that brings everyone together in agreement. It is the answer when you ask for a product that is essential but highly functional and of high quality. Loved by everyone, always.

The optimal balance between performance and price. The meeting point to obtain the best at the right cost.

Kumo can be installed on both walls and ceilings. Its modest dimensions make it the wisest choice for condominiums or limited spaces.

REGISTERED DESIGN 



Tested by:  TÜVRheinland®
Precisely Right.



SCAN ME



Lunghezza del braccio e inclinazione
Arm lenght and inclination

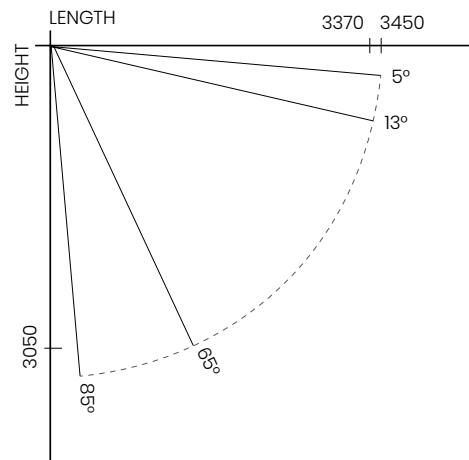

Le misure sono espresse in millimetri
Sizes are expressed in millimeters

Caratteristiche generali

- Tenda a cassetto con bracci estensibili
- Installazione a parete e soffitto
- Inclinazione da 5° a 85°
- Tubo avvolgitore da 80 mm
- Braccio HOME con DATSystem
- Dimensione massima modulo singolo: 600x315 o 540x340 cm
- Manuale o motorizzata
- Regolazione micrometrica continua dell'inclinazione
- Viteria Inox certificata italiana
- Certificazione TÜV Rheinland
- Design brevettato in tutti gli stati della UE

Dimensioni della tenda chiusa
Awning sizes with folded arms

Installazione a parete
Wall installation

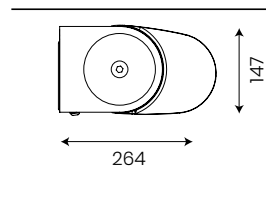

Inclinazione minima 5°
5° minimum inclination

Installazione a parete
Wall installation

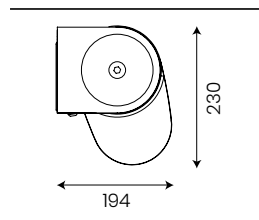

Inclinazione massima 65°
motorizzata, 45° manuale
Maximum inclination
65° motorized, 45° manual

Installazione a soffitto
Ceiling installation

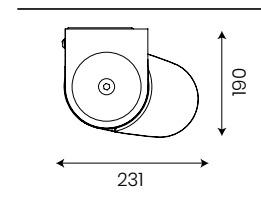

Inclinazione minima 13°
13° minimum inclination

Installazione a soffitto
Ceiling installation

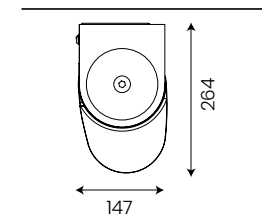

Inclinazione massima 85°
motorizzata, 65° manuale
Maximum inclination
85° motorized, 65° manual

General features

- Retractable arm awning with cassette
- Wall and ceiling installation
- Inclination ranges between 5° and 85°
- Roller tube 80 mm
- Arm HOME with DATSystem
- Maximum sizes of a single section: 600x315 or 540x340 cm
- Manually operated or motorized
- Continuous micrometric regulation of inclination
- Certified Italian Stainless steel screws and pins
- Certified by TÜV Rheinland
- Design patented in all EU Member States

Colori disponibili

Colours available

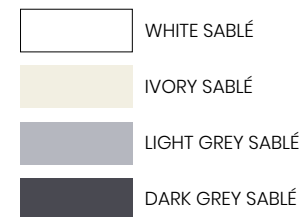





SCAN ME







SCAN ME



YUKI

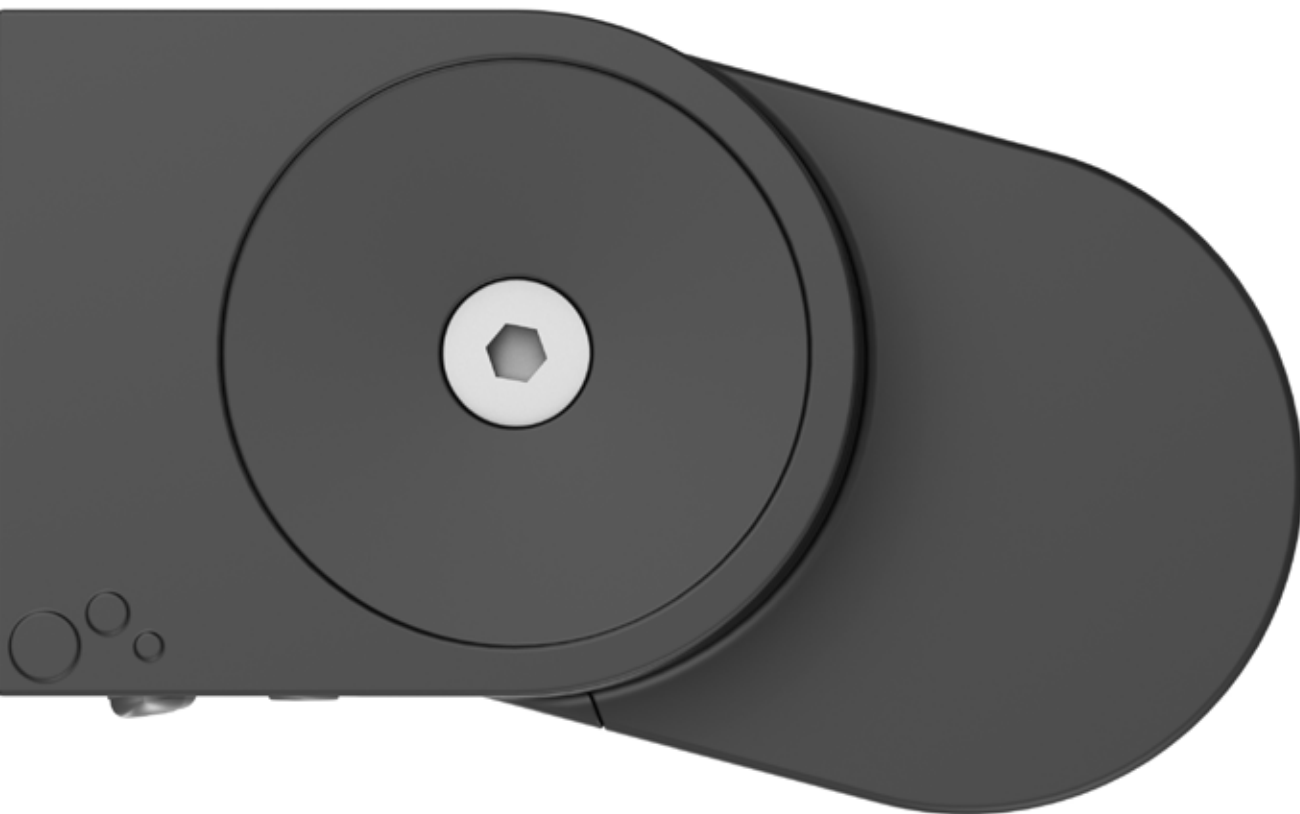

YUKI, l'aggraziata.
Per chi dá valore
ad ogni spazio.

*YUKI, the graceful one.
For those who give value
to every space*

Creata appositamente per rispondere a esigenze di spazio più ristrette. Offre gli stessi benefici di Kumo, in una dimensione ridotta e una spesa ottimizzata.

Ottima per chi desidera valorizzare anche l'area più piccola e vuole conservare bellezza e massime prestazioni.

Il Good Design Award premia Yuki e la riconosce come realizzazione capace di inglobare concept innovativo e utilità.

Specially designed to meet the needs of more limited space. She offers the same benefits as Kumo, in a reduced size and with an optimized cost.

Excellent for those who want to enhance even the smallest area and wish to preserve beauty and maximum performance.

The Good Design Award recognizes Yuki as a product capable of incorporating an innovative concept with utility.

PREMI . AWARDS



Good Design
Award
2014

REGISTERED DESIGN 



Tested by:  TÜVRheinland®
Precisely Right.



SCAN ME

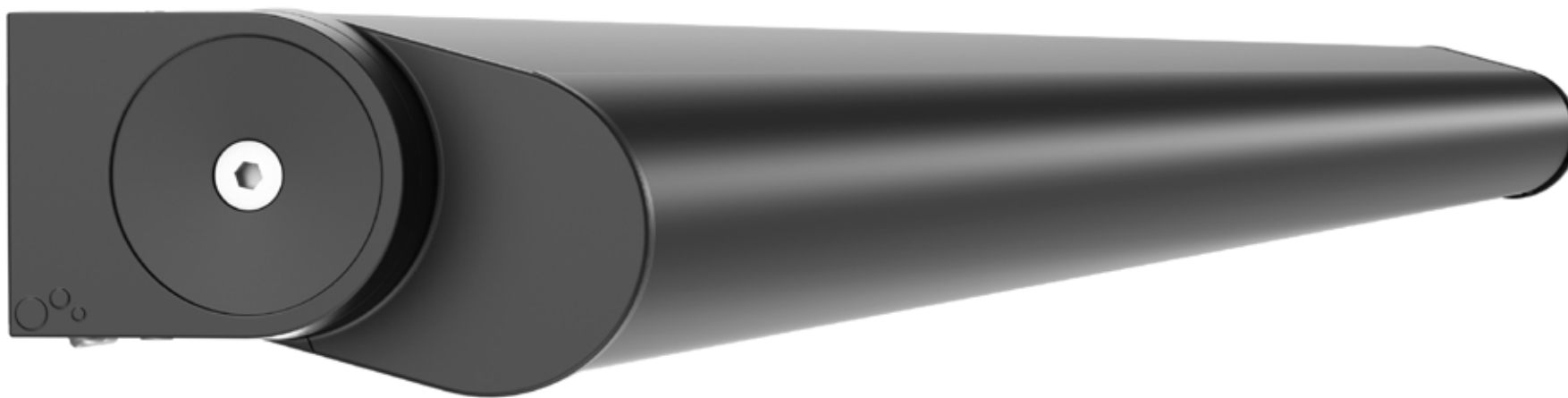

Lunghezza del braccio e inclinazione
Arm lenght and inclination

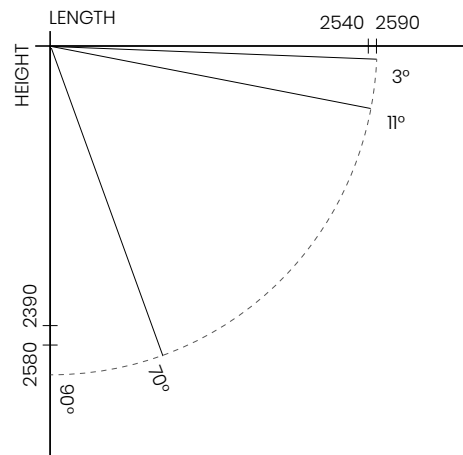

Le misure sono espresse in millimetri
Sizes are expressed in millimeters

Caratteristiche generali

- Tenda a cassonetto con bracci estensibili
- Viteria Inox certificata italiana
- Regolazione micrometrica dell'inclinazione
- Inclinazione da 3° a 90°
- Tubo avvolgitore da 80 mm
- Installazione a parete e soffitto
- Braccio FUSION con DATSystem
- Dimensione massima modulo singolo 480x265 cm
- Manuale o motorizzata

Dimensioni della tenda chiusa
Awning sizes with folded arms

Installazione a parete
Wall installation

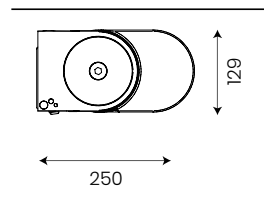

Inclinazione minima 3°
3° minimum inclination

Installazione a parete
Wall installation

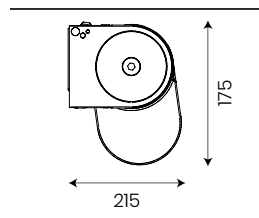

Inclinazione massima
70° motorizzata, 58° manuale
Maximum inclination
70° motorized, 58° manual

Installazione a soffitto
Ceiling installation

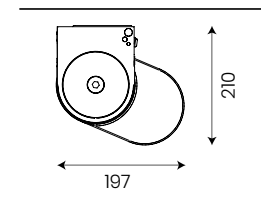

Inclinazione minima 11°
11° minimum inclination

Installazione a soffitto
Ceiling installation

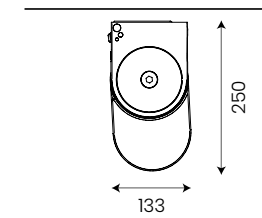

Inclinazione massima
90° motorizzata, 73° manuale
Maximum inclination
90° motorized, 73° manual

General features

- Retractable arm awning with cassette
- Certified Italian Stainless steel screws and pins
- Continuous micrometric regulation of inclination
- Inclination ranges between 3° and 90°
- Roller tube 80 mm
- Wall and ceiling installation
- Arm FUSION with DATSystem
- Maximum sizes of a single section: 480x265 cm
- Manually operated or motorized

Colori disponibili
Colours available

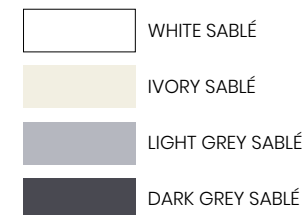





SCAN ME







SCAN ME



ILIOSWING



ILIOSWING, l'elegante.
Per chi cerca la classe.

ILIOSWING, the elegant.
For those in search of class.

Ombreggia i balconi e ripara i portici. Protegge gli ambienti dal sole in modo verticale. Ilios è versatile nell'installazione e appagante alla vista. Ricca di grazia e classe, preserva il design pulito. Esprime praticità in ogni aspetto e in ogni dettaglio.

Per le versioni Wing e Ray, presenta una soluzione unica nel mercato: un terminale che si integra perfettamente all'interno del cassonetto permettendo la chiusura ermetica. Con Ilios hai la serenità di un prodotto affidabile e resistente.

Con Ilios è tutto così comodo. Grazie al pratico sistema Smart-Box è possibile rimuovere facilmente e velocemente la copertina frontale.

Ha trionfato al Red Dot Design award sbaragliando la concorrenza. È una proposta che conquista, ieri come oggi, per efficienza e qualità.

Shades balconies and shelters porches. Protects the environment from the sun in a vertical manner. Ilios is versatile in its installation and pleasing to the eye. Rich in grace and class, it preserves a clean design. It expresses practicality in every aspect and in every detail.

For the Wing and Ray versions, it presents a unique solution in the market: a terminal that integrates perfectly into the container, allowing it to be hermetically sealed. With Ilios you have the serenity of a reliable and resistant product.

Everything is so comfortable with Ilios. Thanks to the practical Smart-Box system, the front covering can be removed quickly and easily.

It triumphed at the Red Dot Design award, beating the competition. It is a winning product, both yesterday and today, for its efficiency and quality.

PREMI . AWARDS



REGISTERED DESIGN 



Tested by:  TÜVRheinland®
Precisely Right.



SCAN ME



Dimensioni di ingombro

Overall dimensions

Installazione a parete o soffitto

Wall and ceiling installation

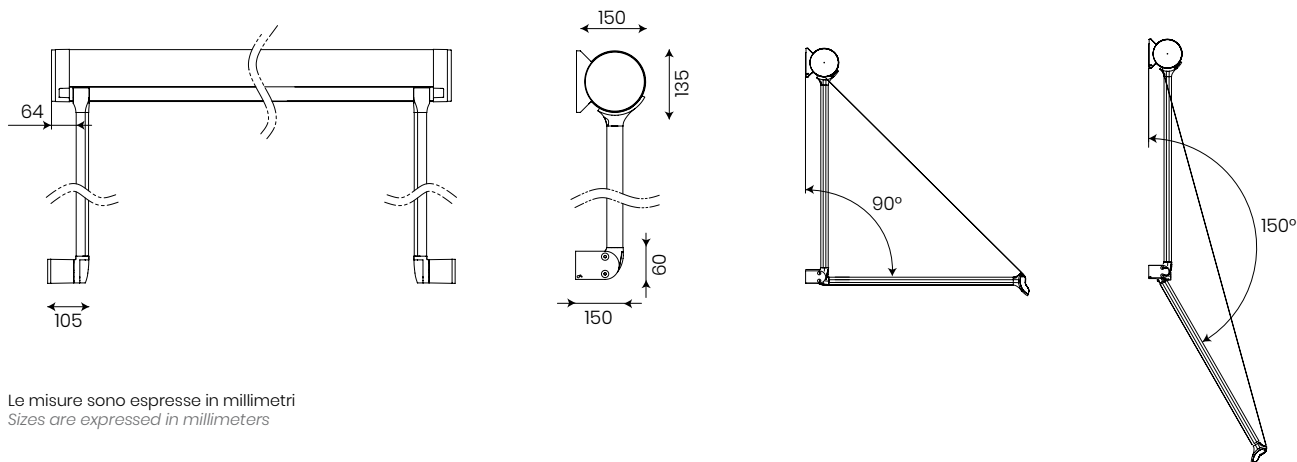

Le misure sono espresse in millimetri
Sizes are expressed in millimeters

Caratteristiche generali

- Cassonetto con terminale a totale scomparsa
- Installazione a parete e soffitto
- Tubo avvolgitore da 80 mm
- Dimensioni massime 450x300 cm (tessuto acrilico)
- Manuale o motorizzata
- Viteria Inox certificata italiana
- Certificazione TÜV Rheinland
- Design brevettato in tutti gli stati UE
- Disponibile con bracci a 90° o a 150°

General features

- Terminal profile totally integrating with the box
- Wall and ceiling installation
- Roller tube 80 mm
- Maximum sizes 450x300 cm (acrylic fabric)
- Manually operated or motorized
- Certified Italian Stainless steel screws and pins
- Certified by TÜV Rheinland
- Design patented in all EU Member States
- Available with arms 90° or 150° inclination

Colori disponibili

Colours available







SCAN ME



YAMA



YAMA, l'innovazione
che incontra la tradizione.

*YAMA, innovation
meets tradition.*

Una barra quadra della tradizione con l'innovazione dell'illuminazione a LED, cui design squadrato ricorda la nostra maestosa Shan.

Linee pulite e decise si intersecano per creare una tenda nuova ed accattivante, adatta a chi vuole osare.

YAMA, il mix perfetto che racchiude l'anima di tutte le tende a bracci di ShadeLAB.

A traditional square bar with the innovation of LED lighting, whose square design is reminiscent of our majestic Shan.

Clean, bold lines intersect to create a new, eye-catching curtain for those who want to be daring.

YAMA, the perfect mix that encompasses the soul of all awnings from ShadeLAB.

REGISTERED DESIGN 



Tested by:  TÜV Rheinland®
Precisely Right.



SCAN ME



Lunghezza del braccio e inclinazione
Arm lenght and inclination

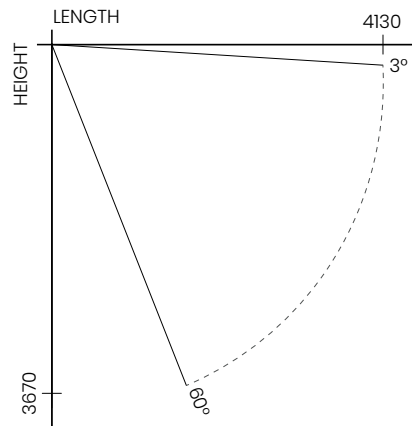

Le misure sono espresse in millimetri
Sizes are expressed in millimeters

Caratteristiche generali

- Viteria Inox certificata italiana
- Regolazione micrometrica dell'inclinazione
- Inclinazione da 3° a 60°
- Tubo avvolgitore da 80 mm
- Installazione a parete o soffitto (con staffe dedicate)
- Braccio URBAN KATANA con DATSystem
- Dimensione massima modulo singolo 700x415 cm
- Manuale o motorizzata
- Braccio URBAN KATANA LED
- Disponibile o con opzione led sui bracci o sul terminale
- Supporti braccio rinforzati

Dimensioni della tenda chiusa
Awning sizes with folded arms

Installazione a parete
Wall installation

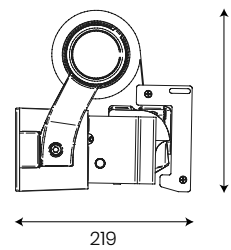

Inclinazione minima 3°
3° minimum inclination

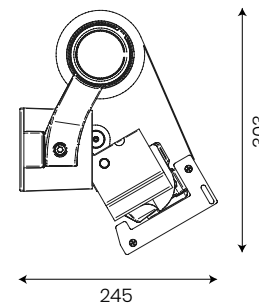

Inclinazione massima 60°
60° Maximum inclination

Installazione a soffitto
Ceiling installation

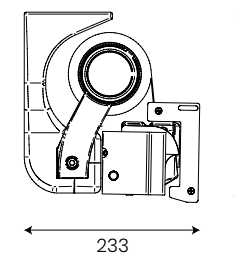

Inclinazione minima 3°
3° minimum inclination

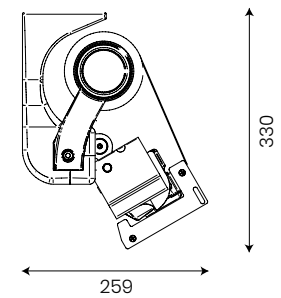

Inclinazione massima 60°
60° Maximum inclination

General features

- Certified Italian Stainless steel screws and pins
- Continuous micrometric regulation of inclination
- Inclination ranges between 3° and 60°
- Roller tube 80 mm
- Wall and ceiling installation (with dedicated brackets)
- Arm URBAN KATANA with DATSystem
- Maximum sizes of a single section: 700x415 cm
- Manually operated or motorized
- Urban URBAN KATANA LED arm
- Available or with LED option on the arms or on the terminal
- Reinforced arm supports

Colori disponibili
Colours available







SCAN ME



SVET



SVET, l'originale.
Per chi conosce
il valore dell'arte.

*SVET, the original one.
For those who know
the value of art.*

Svet è un pezzo da collezione. Se non hai paura di osare, se per i tuoi ambienti ricerchi oggetti particolari, se presti attenzione ad ogni dettaglio...lei è la risposta.

L'animo artistico che da sempre alberga in te trova in Svet una rivelazione.

Sopra le righe, è la preferita di chi fa del gusto estroso la sua stretta di mano con il mondo.

Svet is a collector's item. If you are not afraid to dare, if you are looking for particular objects for your environment, if you pay attention to every detail...she is the answer.

The artistic soul that has always been in you finds in Svet a revelation.

Over the top, she is the favourite of those whose fanciful taste is their handshake with the world.

REGISTERED DESIGN 



Tested by:  TÜV Rheinland®
Precisely Right.





SCAN ME



Lunghezza del braccio e inclinazione
Arm lenght and inclination

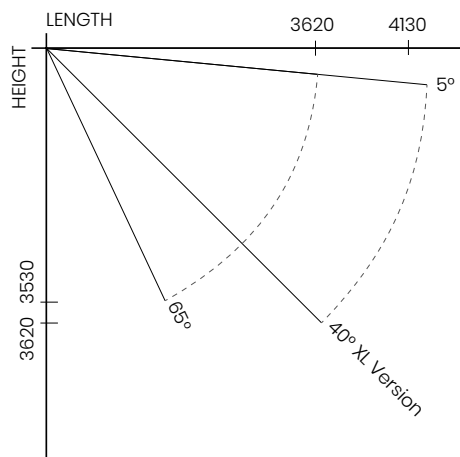

Le misure sono espresse in millimetri
Sizes are expressed in millimeters

Caratteristiche generali

- Viteria Inox certificata italiana
- Installazione a parete o a soffitto (con staffe Klip)
- Regolazione micrometrica continua dell'inclinazione
- Inclinazione da 3° a 40°
- Tubo avvolgitore da 80 mm
- Braccio URBAN con DATSystem
- Dimensione massima modulo singolo 700x365 cm
- Manuale o motorizzata
- Disponibile con tettuccio protettivo
- Disponibile con sporgenza 415 con supporto XL
- Optional nuovo braccio URBAN LED

Dimensioni della tenda chiusa
Awning sizes with folded arms

Installazione a parete
Wall installation

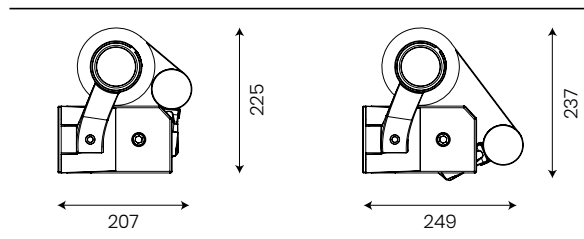

Inclinazione minima 3°
3° minimum inclination

Inclinazione massima 65°
65° Maximum inclination

Installazione a parete versione XL
Wall installation XL version

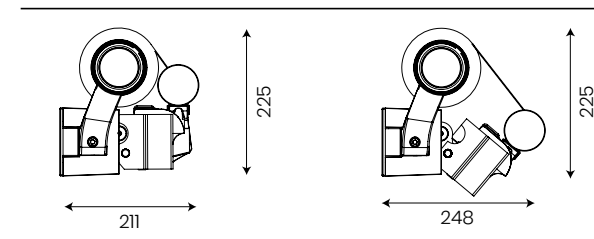

Inclinazione minima 3°
3° minimum inclination

Inclinazione massima 40°
40° Maximum inclination

General features

- Certified Italian Stainless steel screws and pins
- Wall and ceiling installation (with Klip bracket)
- Continuous micrometric regulation of inclination
- Inclination ranges between 3° and 40°
- Roller tube 80 mm
- Arm urban with DATSystem
- Maximum sizes of a single section: 700x365 cm
- Manually operated or motorized
- Available with protective hood
- 415 cm projection also available with XL arm support
- Available with new URBAN LED Arm

Colori disponibili

Colours available



WHITE SABLÉ



DARK GREY SABLÉ





SCAN ME



KLIP



KLIP, la seducente.
Per chi sa che l'occhio
vuole la sua parte.

*KLIP, the seductive one.
For those who know
that looks matter.*

Klip appartiene alla categorie di barre quadre di Shadelab, la serie che ha reinventato un'era.

Questo è un dato di fatto. Prima le barre quadre erano solo funzionali, con le nostre creazioni sono diventate affascinanti, incantevoli, meravigliose da vedere.

Klip e le sue compagne hanno segnato un passaggio e fatto la storia. Nella sua nudità tutti i componenti sono ricercati per creare la tua ombra con lo stile che ti contraddistingue.

Klip belongs to Shadelab's category of square bars, the series that has reinvented an era.

That's a fact. Before, the square bars were only functional, but with our creations they have become charming, enchanting, and glorious to behold.

Klip and her companions have marked a transition and made history. In its bareness all the components are refined to create your shading with the style that distinguishes you.

REGISTERED DESIGN 



Tested by:  TÜV Rheinland®
Precisely Right.

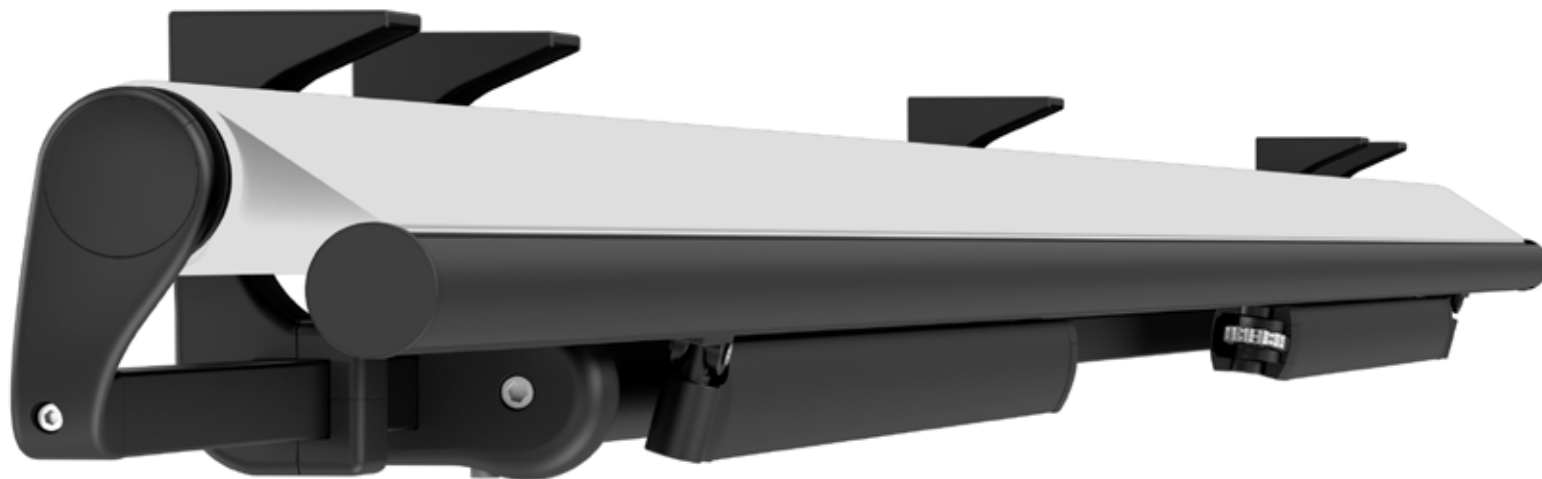

SCAN ME



Lunghezza del braccio e inclinazione
Arm length and inclination

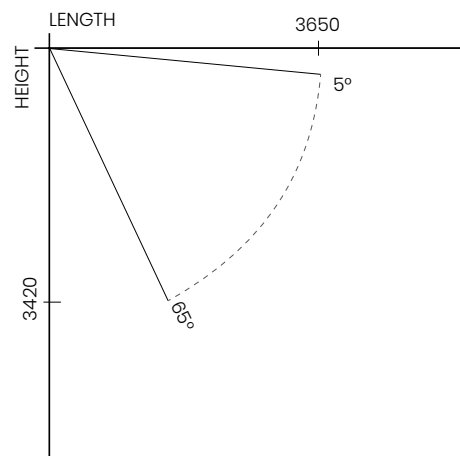

Le misure sono espresse in millimetri
Sizes are expressed in millimeters

Caratteristiche generali

- Tubo avvolgitore da 80 mm
- Braccio Home con DATSystem
- Manuale o motorizzata
- Regolazione micrometrica continua dell'inclinazione
- Disponibile con tettuccio protettivo
- Viteria Inox certificata italiana
- Certificazione TÜV Rheinland
- Design brevettato in tutti gli stati della UE
- Installazione a parete o soffitto
- Inclinazione da 5° a 65°
- Dimensione massima modulo singolo 700x365 cm
- Optional nuovo braccio URBAN LED
- Disponibile con sporgenza 415 cm con supporto XL e braccio Urban

Dimensioni della tenda chiusa
Awning sizes with folded arms

Installazione a parete o soffitto o nicchia
Wall or ceiling or niche installation

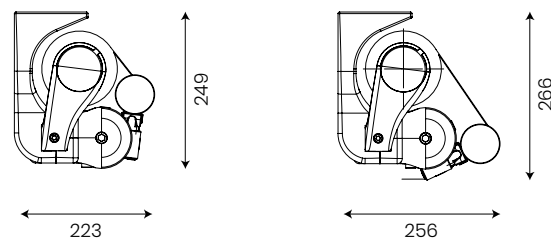

Inclinazione minima 5°
5° minimum inclination

Inclinazione massima 65°
65° Maximum inclination

General features

- Roller tube 80 mm
- Arm HOME with DATSystem
- Manually operated or motorized
- Continuous micrometric regulation of inclination
- Available with protective hood
- Certified Italian Stainless steel screws and pins
- Certified by TÜV Rheinland
- Design patented in all EU Member States
- Wall or ceiling installation
- Inclination ranges between 5° and 65°
- Maximum sizes of a single section: 700x365 cm
- New URBAN LED Arm available
- 415 cm projection also available with XL arm support and Urban arm

Colori disponibili
Colours available







SCAN ME



STEIN



STEIN, l'intrigante.
Per chi vuole una soluzione
ammaliante.

*STEIN, the intriguing one.
For those who want
a mesmerizing solution.*

Una barra quadra progettata e creata per un'applicazione al soffitto.

Esci in terrazza e non puoi fare a meno di ammirare Stein, il tuo acquisto più riuscito.
Una visione di straordinaria armonia e forme equilibrate.

La massima espressione di eleganza e forza.

A square bar designed and created for a ceiling application.

*Step out onto the terrace and you can't help but admire Stein, your most successful purchase.
A vision of extraordinary harmony and balanced shapes.*

The ultimate expression of elegance and strength.

REGISTERED DESIGN 



Tested by:  **TÜVRheinland®**
Precisely Right.



SCAN ME



Lunghezza del braccio e inclinazione
Arm length and inclination

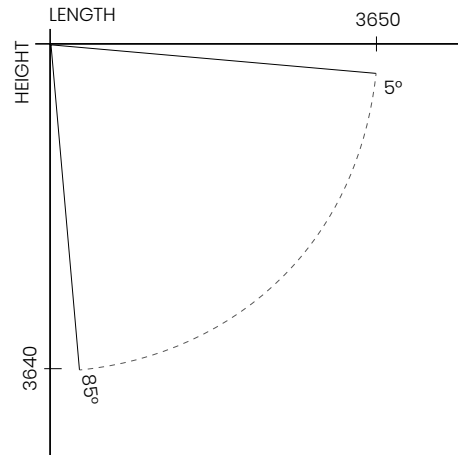

Le misure sono espresse in millimetri
Sizes are expressed in millimeters

Caratteristiche generali

- Tubo avvolgitore da 80 mm
- Braccio Home con DATSystem
- Manuale o motorizzata
- Regolazione micrometrica continua dell'inclinazione
- Disponibile con tettuccio protettivo
- Viteria Inox certificata italiana
- Certificazione TÜV Rheinland
- Design brevettato in tutti gli stati della UE
- Installazione a parete o soffitto
- Inclinazione da 5° a 85°
- Optional nuovo braccio URBAN LED
- Dimensione massima modulo singolo 700x365 cm

Dimensioni della tenda chiusa
Awning sizes with folded arms

Installazione a parete o soffitto
Wall or ceiling installation

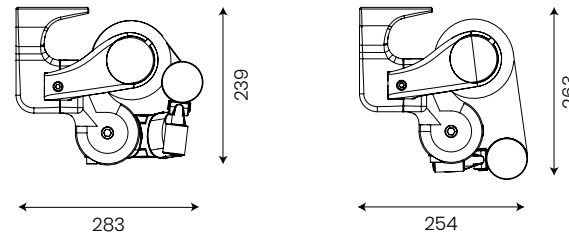

Inclinazione minima 5°
5° minimum inclination

Inclinazione massima 85°
85° Maximum inclination

General features

- Roller tube 80 mm
- Arm HOME with DATSystem
- Manually operated or motorized
- Continuous micrometric regulation of inclination
- Available with protective hood
- Certified Italian Stainless steel screws and pins
- Certified by TÜV Rheinland
- Design patented in all EU Member States
- Wall or ceiling installation
- Inclination ranges between 5° and 85°
- New URBAN LED Arm available
- Maximum sizes of a single section: 700x365 cm

Colori disponibili
Colours available







SCAN ME



CONTATTI . CONTACTS



Sede legale . Headquarter

Via 1° maggio, 7
30029 San Stino di Livenza, Venezia, Italy

T. +39 0421 189 61 57
E. info@shadelab.it
W. www.shadelab.com

Seguici su . *Follow us on*



SCAN ME



